

## Front Service PowerCore® Air Cleaner with detachable pre-cleaner

PowerCore® Edge brings the smallest footprint yet to the PowerCore air cleaner line, without sacrificing performance.

Ideally suited for medium to heavy dust environments, this front service air cleaner offers a built-in detachable pre-cleaner that allows for quick and easy servicing if it should ever plug in extreme conditions.

### Applications

- Off-road equipment operating in medium to heavy dust conditions with engine airflow ranges up to 388 cfm / 11m<sup>3</sup>/min.

- Permanent scavenge line connection stays in place while filter servicing occurs.
- Horizontal or vertical mounting options. Obround housing shape allows for a narrow or wide orientation.
- Sustained temperature tolerance: -40 °F to 212 °F / -40 °C to 100 °C

### Features

- More compact at a given performance level than standard pleated filter air cleaners and slightly smaller than comparable PSD air cleaners
- High efficiency integrated pre-cleaner easily separates into

two pieces for quick and easy servicing

- Non-metal filters
- Improved engine protection: no media movement, expansion, contraction or bunching
- Improved contaminant encapsulation: dust and dirt stay contained in filter during service
- Improved handling and maintenance: lighter and smaller
- Easily serviced; no tools required to remove or replace cover
- Can be used with scavenge line or Vacuator™ Valve
- Built-in mounting brackets eliminate the need to purchase separate mounting bands

### PowerCore Edge

#### Easy front servicing

The snap-fit latches require less space to operate than traditional latches. They can be locked in "open" position by pushing the front of the latch after they have been opened.

#### Improved pre-cleaner maintenance

Designed to easily separate into two pieces to allow for fast and easy cleaning

#### Unique seal design

Withstands temperatures up to 100°C / 212°F

#### PowerCore® primary air filter

Dust and dirt stay contained during service



#### Next generation pre-cleaner tubes

Bringing greater pre-cleaner efficiency for longer filter life

#### Permanent scavenge line connection on the body (Optional) Benefits:

- Easy access to the filter servicing
- Reduced overall service time
- 100% secured scavenge connection

#### Filter Minder integrated visual indicator or wireless technology (Optional)

Choose integrated visual indicator or real-time wireless information

#### Flexible mounting options

Allows for a range of installation locations and attachment configurations



## D Air in the End, Out the Opposite End



### When Selecting an Air Cleaner . . .

Determine the airflow requirements of your engine, then find the corresponding cfm / m<sup>3</sup>/min. airflow in the table below. The restriction numbers indicate the approximate initial restriction of each model air cleaner at that cfm / m<sup>3</sup>/min. If there are two air cleaner models that fit your parameters, choosing the one with the lower restriction will provide longer filter service life. When calculating total initial restriction of the entire air intake system, include the restriction caused by ducting, elbows, and pre-cleaners. See pages 271-272 for ducting restriction estimates.

### PowerCore Edge Air Cleaners and Scavenge Air Systems

PowerCore Edge air cleaners are designed to operate with or without aspiration, otherwise known as scavenging. PowerCore Edge performance charts include scavenged performance data.

#### Initial Airflow Restriction (non-scavenged)

CFM @ "H <sub>2</sub> O			m <sup>3</sup> /min. @mbar			Air Cleaner Model
6"	8"	10"	15 <sub>mbar</sub>	20 <sub>mbar</sub>	25 <sub>mbar</sub>	
206	242	273	5.8	6.9	7.7	D080186
206	242	273	5.8	6.9	7.7	D080187
201	234	264	5.7	6.6	7.5	D080188
267	310	349	7.6	8.8	9.9	D090357
257	301	339	7.3	8.5	9.6	D090358
254	400	337	7.2	8.4	9.5	D090359

### PowerCore Edge Air Cleaner Performance Curves\*

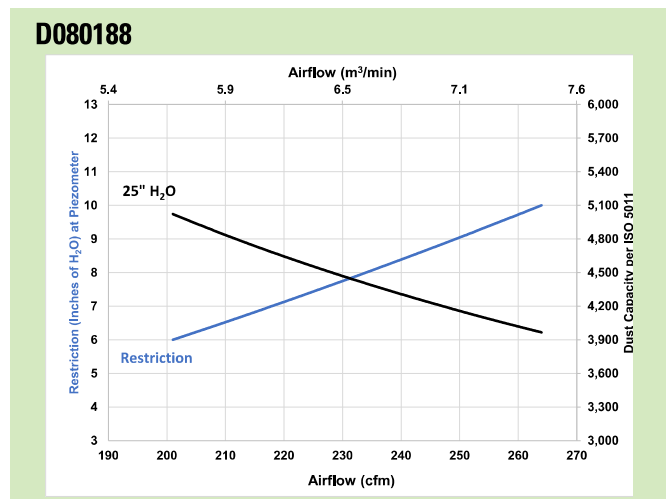
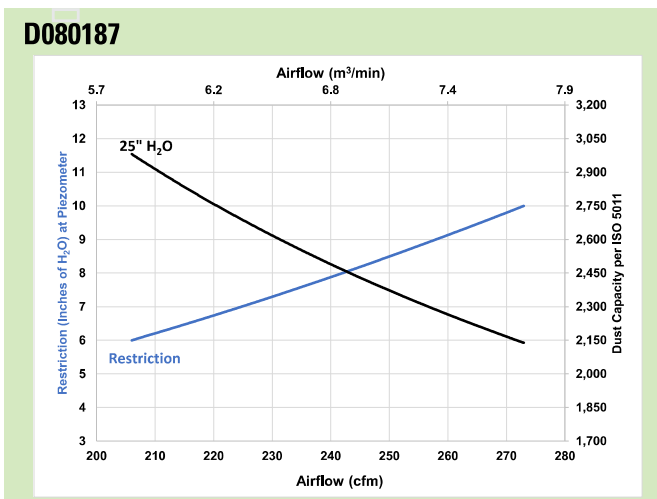
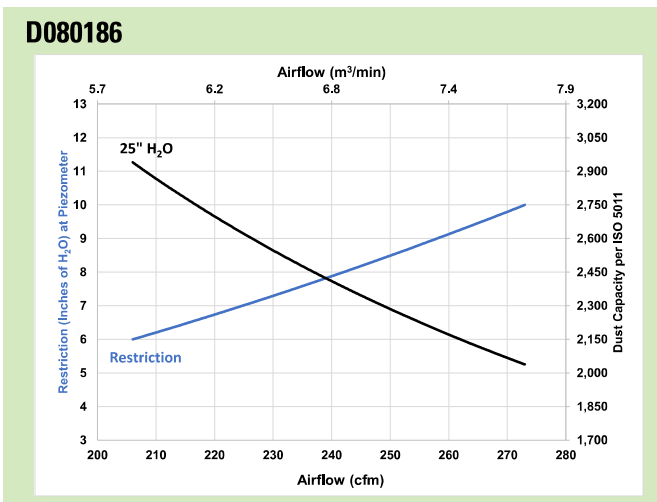

\*Results generated using laboratory testing pursuant to ISO5011. Actual performance during use may vary depending on multiple factors, including specific product configuration, external conditions and application.

**D090357**

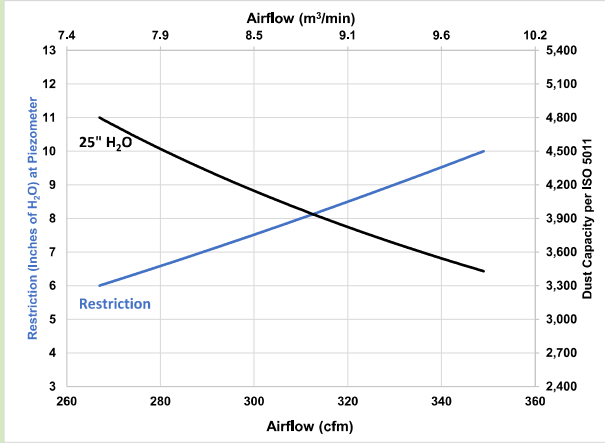

**D090358**

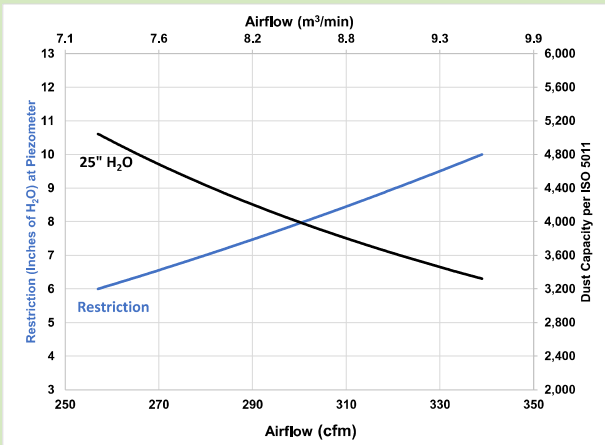

**D090359**

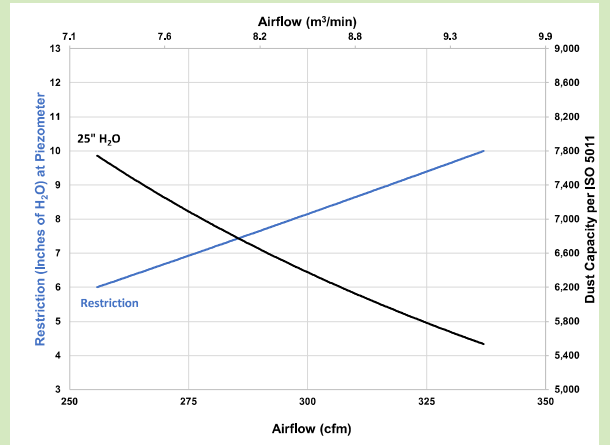

\*Results generated using laboratory testing pursuant to ISO5011. Actual performance during use may vary depending on multiple factors, including specific product configuration, external conditions and application.



PowerCore Edge 08 & PowerCore Edge 09

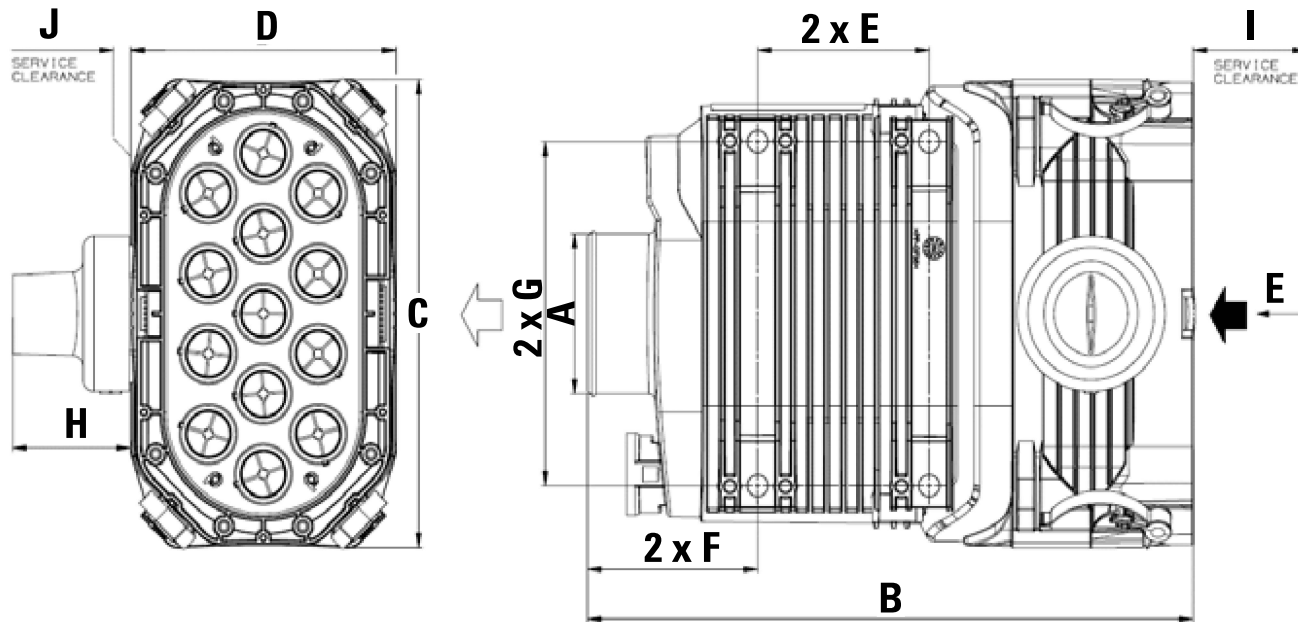

**PowerCore Edge Specifications** (Letters are keyed to drawings)

Orientation: H=Horizontal; V=Vertical

Part No. / Orientation	A mm/in	B mm/in	C mm/in	D mm/in	E mm/in	F mm/in	G mm/in	H mm/in	I mm/in	Service Clearance (J) mm/in	Weight kg/lbs
<b>MODELS WITH SERVICE ACCESS ON SIDE</b>											
D080186 H	89/3.50	353/13.9	260/10.2	155/6.1	100/3.9	99/3.9	191/7.5	69/2.7	115/4.5	10/0.4	2.4/1.1
D080187 V	89/3.50	353/13.9	260/10.2	155/6.1	100/3.9	99/3.9	191/7.5	69/2.7	115/4.5	10/0.4	2.4/1.1
D080188 V*	89/3.50	353/13.9	260/10.2	155/6.1	100/3.9	99/3.9	191/7.5	92/3.6	115/4.5	10/0.4	2.4/1.1
D090357 H	101/40	402/15.8	357/14.1	147/5.8	115/4.5	99/3.9	296/11.6	69/2.7	140/5.5	10/0.4	3.2/1.5
D090358 V	101/40	402/15.8	357/14.1	147/5.8	115/4.5	99/3.9	296/11.6	69/2.7	140/5.5	10/0.4	3.2/1.5
D090359 V*	101/40	402/15.8	357/14.1	147/5.8	115/4.5	99/3.9	296/11.6	92/3.6	140/5.5	10/0.4	3.2/1.5

\* Scavenge-ready

**Scavenged System Mounting** (shaded air cleaners indicate proper mounting positions; indicates scavenge line direction)

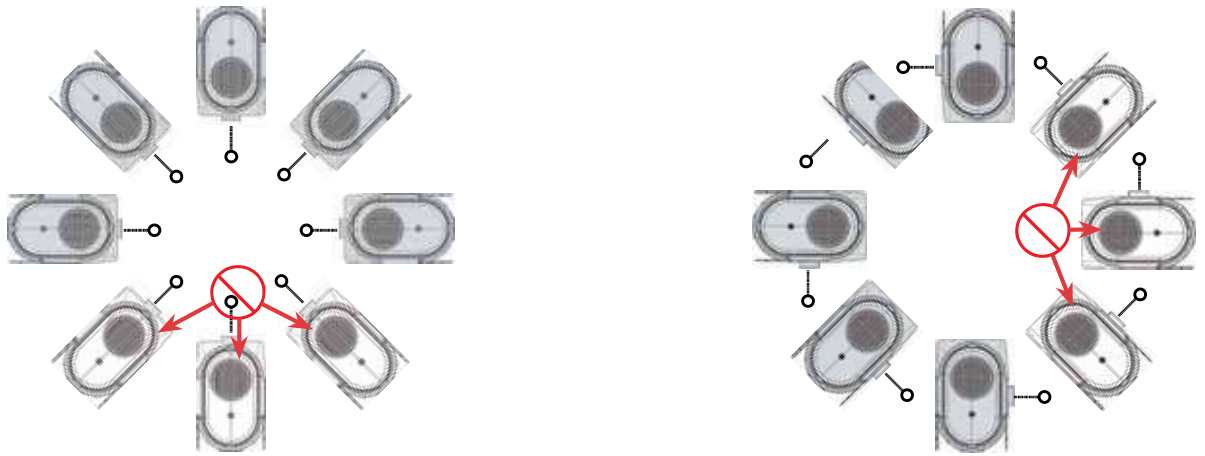

**Non-Scavenged System Mounting with Vacuator™ Valve** (shaded air cleaners indicate proper mounting positions)

Vertical Edge enlarged to show Vacuator™ Valve detail.

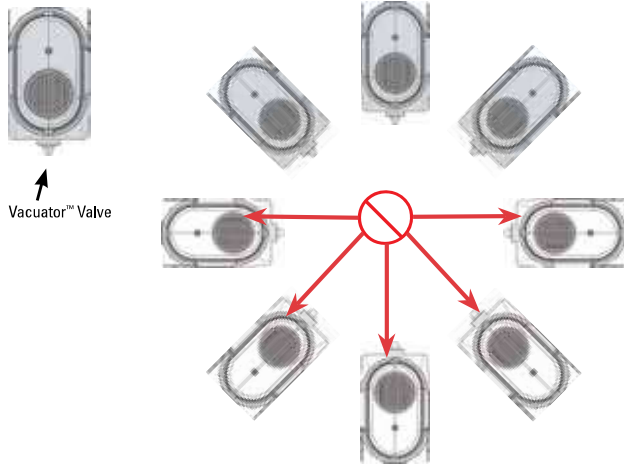

Horizontal Edge enlarged to show Vacuator™ Valve detail.

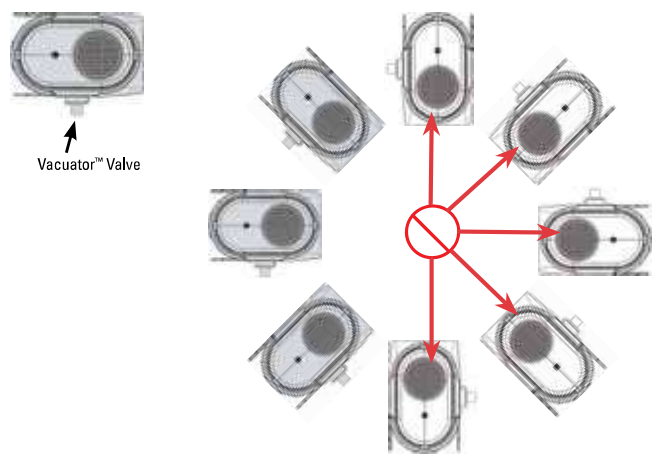



This servicing information is provided as a best practices guide. It is not intended to replace or supersede the service instructions supplied by your engine or vehicle manufacturer. Note: Your air cleaner service cover may be in a different position than shown.

## 1 Check the Restriction

Replace the filter only when the restriction level has reached the maximum recommended by the engine or equipment manufacturer or on a regular scheduled service.



## 2 Check Vacuator™ Valve

Shut off the engine. Inspect the Vacuator™ Valve (or scavenge line) for damage and release any remaining dust. If damaged, replace.



## 3



Unlock the pre-cleaner cover by pressing the side clips. Open the pre-cleaner cover to clean the chamber.





## 4 Replace the primary and safety filters

Remove the primary filter by pulling on the handles. Replace the primary filter with a new Donaldson PowerCore® Edge primary filter.



## 5 Close pre-cleaner and housing

Put the pre-cleaner back onto the filter housing. Close the main housing using the four metal latches. Ensure that all four latches are properly closed for optimal performance.



## 10 Inspect the Entire Air Cleaner System

Make sure that inlet and outlet connections are in good condition. Torque to and do not exceed 40 in•lb. Replace rubber connectors if necessary and reset the service indicator.





## Service Parts & Accessories

### **D080186, D080187, D080188** Edge

Pre-Cleaner – D080186 Horizontal	P957804 ...3
Pre-Cleaner – D080187 & D080186 Vertical	P601735 ...3
Elbow, 45°	P109331
Elbow, 90°	P114318
Filter, primary	P958647 ...3
Filter, safety	P957712 ...3
Hump hose	P114319
Informer™ indicator 25" H <sub>2</sub> O	X002277
Latch	P957720 ...3
Outlet band clamp	P148342
U-clip (4 clips)	P786050
Vacuator™ Valve	P112803 ...3

### **D090357, D090358, D090359** Edge

Pre-Cleaner – D090357 Horizontal	P957851 ...3
Pre-Cleaner – D090358 & D090359 Vertical	P957850 ...3
Elbow, 45°	P105545
Elbow, 90°	P105533
Filter, primary	P958648 ...3
Filter, safety	P957732 ...3
Hump hose	P105609
Informer™ indicator 25" H <sub>2</sub> O	X002277
Latch	P957720 ...3
Outlet band clamp	P148343
U-clip (4 clips)	P784517
Vacuator™ Valve	P112803 ...3

#### NOTES:

3 = Shipped with air cleaner initially